

Operator Instruction Manual



TG 60 / 268

Lovibond® Colour Measurement



938240 Version 1.0

Safety Instructions

Attention. The instrument is a safe device. Before operating, please read the safety instructions and comply strictly with the following terms to avoid unexpected damage. We shall not be liable for any damage from incorrect operation.

Battery

The instrument contains a built-in battery. Please use the original one. Do not insert other batteries. This may damage the instrument.

Do not disassemble, remove or heat the battery.

Once fully charged, please unplug the external power supply.

Please charge the battery every two weeks if the instrument is not being used to avoid damaging the battery.

For the first three times, please charge the battery fully to ensure it reaches its optimal state.

External Power Source

Please use the original power adapter to charge the battery to avoid the chance of shortening the battery life or causing it to explode.

Please unplug the external power source if you are not using the instrument for some time.

Gloss Meter

Do not use the instrument in an inflammable or explosive environment.

Do not disassemble the instrument which may cause damage or an explosion.

Please stop using the instrument if you smell something burning. Send it back to the repair centre.

Table of Contents

- Safety Instructions 2**
- Table of Contents..... 3**
- 1.0 Introduction 4**
- 2.0 External Features 6**
- 3.0 Operating Instruction 7**
 - 3.1 Turn on/off..... 7*
 - 3.2 Calibration..... 8*
 - 3.3 Measurement..... 10*
 - 3.4 Connecting to PC..... 17*
 - 3.5 Printing..... 18*
- 4. System Function Description..... 18**
 - 4.1 Data Management..... 18*
 - 4.2 Mode Selection..... 24*
 - 4.3 Mode Parameter..... 24*
 - 4.4 Angle Selection..... 29*
 - 4.5 Tolerance Settings..... 29*
 - 4.6 Function Setting..... 30*
- 5. Routine Maintenance..... 31**
- 5. Technical Specifications 32**
- 6. Sales Offices 33**

1.0 Introduction

The gloss meter complies to ISO 2813 (International Standard). The gloss meter features a large, interactive touch screen and QC software. It is easy to use, stable in its performance and accurate in measurement

Advantages

1. Large touch screen (3.5inch), high resolution (480*320), full-view display.
2. Complies with ISO 2813, ASTM D 523, GB/T 9754 standards.
3. Aesthetic design perfectly combined with ergonomics structure.
4. Three measurement angles (20°, 60°, 85°) can measure simultaneously (multi angle gloss meter).
5. Three operating modes, multi-function settings.
6. QC software with powerful extending function.
7. Input standard data manually, easy to operate.
8. High hardware configuration with multiple innovative technologies.
9. Auto power-off function to save electricity consumption.

Cautions

The gloss meter is a precise measuring instrument. Please avoid dramatic change of external environment when measuring. Those changes include the flickering of light, a rapid change in temperature and / or humidity.

Keep the instrument balanced. Make sure the measuring aperture is held tight to the test sample, and do not shake or shift it when measuring. Please prevent the gloss meter from any knocks or bangs. This instrument is not water-proof. Do not use it in an environment of high humidity or mist.

Keep the instrument clean. Avoid dust, powder or solid particles entering the measuring aperture and accessories.

After use, please turn off. Keep the instrument and calibration plate in the instrument case.

Users may not make any changes to the instrument without permission since that may affect the measuring accuracy or even damage the instrument.

2.0 External Features

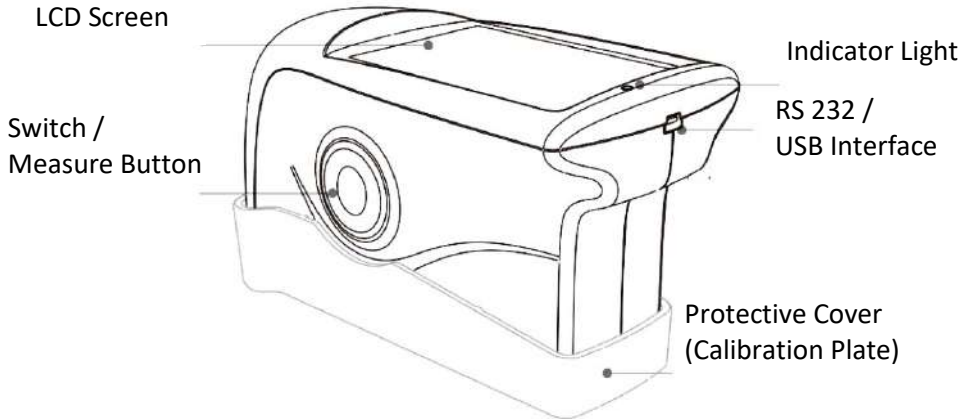

Figure 1: Features

LCD Screen: Displays measurement data and instrument navigation buttons.

Switch/Measure Button: Press the button for 3 seconds to turn the gloss meter on and off. Press the button quickly to take a measurement.

Indicator Light: When turning on, this displays green. After start-up, the light turns off. When power is low or the instrument is charging, it will display a red light. Fully charged will show green.

USB interface: The instrument automatically recognizes the connection status. The USB interface is used to transfer data to a PC. It can also be used to connect the power adapter to a computer to charge the gloss meter (specification: 5V, 2A). The RS-232 interface is used to connect to the printer.

Protective Cover (Calibration plate): This protects the measuring aperture. The built-in calibration plate is used for instrument calibration.

Note: To separate the protective cover from the instrument, refer to

Figure 2. Hold the instrument with one hand, and remove the cover by gently pulling the “Open” mark. You only need to separate it from one side. Do not separate it from two sides.

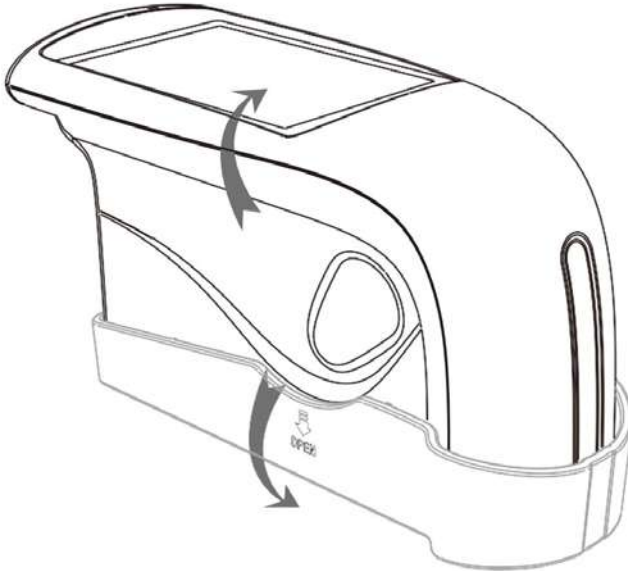

Figure 2: Separation Method

3.0 Operating Instruction

3.1 Turn on/off

Press the switch button for 3 seconds to turn on the instrument. The LCD screen will display the boot logo. After a few seconds, it will automatically enter into the measurement interface as shown in Figure 3. Press the switch button again for 3 seconds, the instrument will turn off.

		Basic Mode		
T005		20	60	85
		16:35	2015.10.23	
T001	T 102316	22.5	21.5	21.3
T002	T 102316	23.8	24.8	26.6
T003	T 102316	33.3	31.5	32.7
T004	T 102316	45.5	42.9	42.1
T005	T 102316	60.5	66.3	63.9
Delete		Menu		

Figure 3: Standard Mode Measurement

3.2 Calibration

In the screen shown in Figure 3, click “Menu” to the main menu as shown in Figure 4.

Select “Calibrate” to enter into Calibration mode as shown in Figure 5.

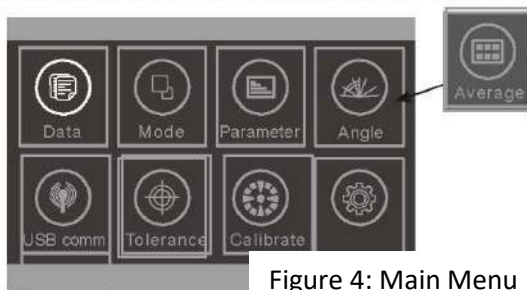

Figure 4: Main Menu

Note: The single angle gloss meter does not have this selection option. The substitute option is basic mode average measurement



Figure 5: Sub-menu Interface for Calibration

3.2.1 Calibration

Click “Calibrate”, it will remind you to install the calibration plate. Make sure the calibration plate is installed correctly on the instrument. Click “OK” or press the measurement button to start calibration.

If the instrument is being used in an unstable environment (such as extreme or variable temperatures, altitude and humidity), a calibration must be carried out.

In order to ensure accuracy, always use the original standard plate for calibration. Any dust on the standard plate will affect the accuracy of the calibration. Keep the standard plate clean. The standard plate is a precise optical component. Please do not leave it under strong lights. Environmental factors will have an effect on the gloss value of the standard plate over time. It is therefore recommended that it is returned to the factory or a qualified local National Institute of Metrology for calibration yearly.

Note: The SN (serial number) corresponds to the internal number of the instrument. In the calibration interface, it will show the “Calibration Plate Number”. It is important to note this if you are working with more than one gloss meter.

3.2.2 Change Calibration Values

Click “Change Cal. Values”. The user can select between “Change 20° cal. Value”, “Change 60° cal. Value” and “Change 85° cal. Value.”

Note: Extreme caution should be taken when operating in this menu. It is normally recommended that these values should be modified by the manufacturer or a qualified metrology institute. These calibration values only need to be modified when they differ

from the values of the actual calibration plate. Before modifying, please back up the original values.

3.3 Measurement

The instrument has three measurement modes: “Basic Mode”, “Statistical Mode” and “Continuous Mode”. These can be selected in the Main Menu per Figure 6.

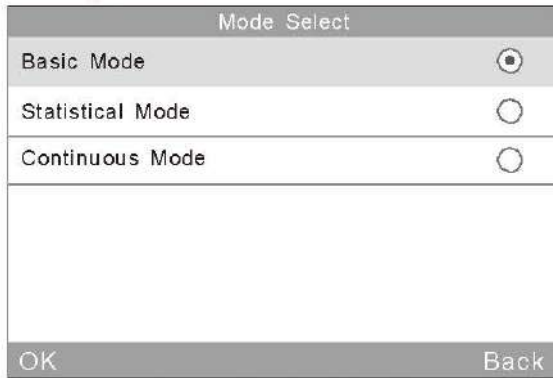



Figure 6: Mode Selection

Basic Mode: This is a basic test that provides a single measurement. The results will be saved automatically each time. This data can be used as the standard in Statistic Mode. It can display 5 sets of test data simultaneously.

Statistical Mode: This provides a statistical evaluation and can measure a single sample multiple times. If the “difference” switch is selected, it displays the variance to the sample standard.

Continuous Mode: Continuous measuring times can be set to 99. Interval times can also be selected. When the “Test” button is pressed, the instrument will start to measure automatically according to the settings.

If the “Test” button is then pressed during the measurements, it will pause or finish the current measurement. This mode is used to measure large sample areas and evaluate the consistency of large sample areas.

The instrument has three measurement angles: 20°, 60° and 85°. These can be selected by clicking “Mode” in the Main Menu or the  icon to enter the interface as shown in Figure 7.

Note: The single angle gloss meter does not have this option.

Angle Select	
20°	<input type="radio"/>
60°	<input type="radio"/>
85°	<input type="radio"/>
20° 60°	<input type="radio"/>
60° 85°	<input type="radio"/>
20° 60° 85°	<input checked="" type="radio"/>
OK	Back

Figure 7: Angle Selection

3.3.1 Basic Mode Measurement

This mode also provides an average measurement function per section 4.3.1.

1) Single angle measurement in Basic Mode: e.g.: 60°. Press the “Test” button. The instrument will measure the gloss value under 60°, as shown in Figure 8.

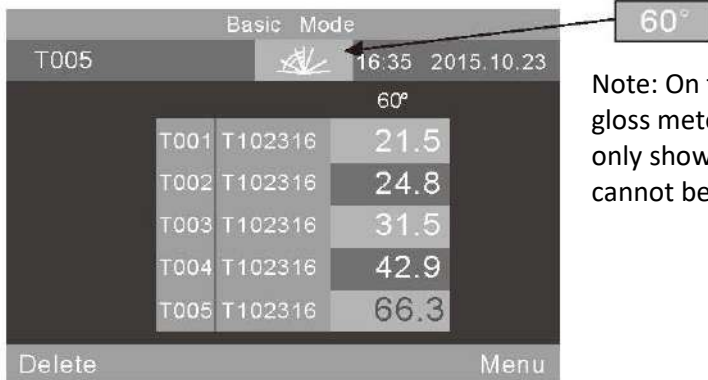

Note: On the single angle gloss meter, this icon will only show one angle and cannot be selected.

Figure 8: Single Angle Measurement Under Basic Mode

Select “Basic Mode” at the top of the screen. It will enter the average measurement interface.

“T005” at the top left of the screen represents the number of the current measurement. The number begins with the letter “T”. The  icon is a shortcut key for angle selection (note: not available on the single gloss meter). “16:33” and “2015.10.23” represent the time and date respectively.

“T001-T005” are the numbers of the five measurements. “T102316” is the default name of the measured record. It is made up from “T”+“month”+“day”+“hour”: so T102316 would represent a basic record measured on October 23 at 16 hrs.

If any record is clicked, a dialog box will appear with two options “Delete Record” and “Edit Name” as shown in Figure 9. If “Delete Record” is selected, a warning box will appear per Figure 22. Click “Ok” to delete this record.

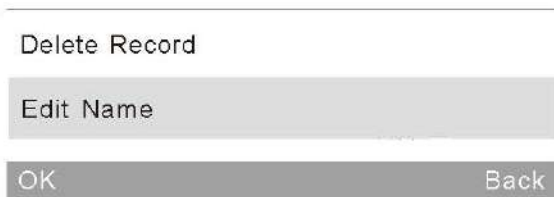

Figure 9: Select Edit Name to enter the Operation Interface

If “Edit Name” is selected, it is possible to modify the name. There is a limit of eight characters (only numbers or letters) as shown in Figure 23.

Click “Delete” in the lower left corner to delete the current record. “60°” means the current measurement is under angle 60°. The last record, “66.3” in yellow, is the current test data. Click “Menu” in the lower right corner to enter the main menu interface.

2) Multi-angle measurement in Basic Mode will display a screen per Figure 10 (Note: the single angle gloss meter does not have this function).

Basic Mode				
T005		16:35 2015.10.23		
		20	60	85
T001	T102316	22.5	21.5	21.3
T002	T102316	23.8	24.8	26.6
T003	T102316	33.3	31.5	32.7
T004	T102316	45.5	42.9	42.1
T005	T102316	60.5	66.3	63.9
Delete		Menu		

Figure 10: Multi Angle Measurement in Statistical Mode

3.3.2 Statistical Mode Measurement

1) Statistical Mode: A single angle measurement is shown in Figure 11.

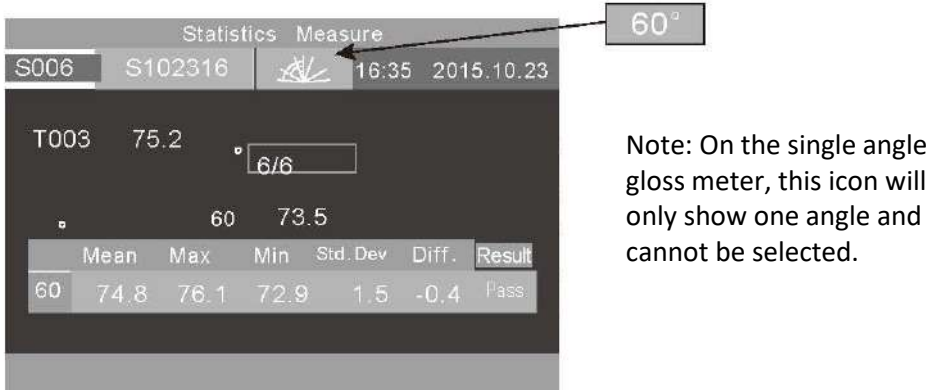



Figure 11: Single Angle Measurement Under Statistical Mode

Click “Statistics Measure” at the top of the screen to enter the statistical mode parameter settings.

“S006” represents the record number of the current measurement which begins with the letter S.

The  icon is a shortcut key for angle selection (Note: not available on the single gloss meter).

“6/6”: The first “6” means the 6th measurement has been taken. The second “6” means the statistical measurement time is 6 (see section 4.3.2 for how to set times for measurements). Once all the measurements have been taken, the values will automatically be saved as a complete statistics record.

“75.2” represents the last measured value.

“74.8, 76.1, 72.9, 1.5, -0.4” represent average value, max value, min value, standard deviation and difference value respectively.

Standard Deviation: The formula is
$$S = \sqrt{\frac{1}{n-1} \sum_{i=1}^n (x_i - \bar{x})^2}$$

Difference: The difference between the sample and the target value.

Result: “Pass” means the sample is qualified and the result is within the tolerance range. “Fail” means the sample is not within the tolerance range (please see section 4.5 for Tolerance Setting).

On completion of the current measurement, the record can be deleted by selecting the “Delete” button.

Note: the standard value, standard deviation and difference will only display when the difference switch is activated.

2) Multi-angle measurement in Statistical Mode. As shown in Figure 12, the angles are: 20°, 60°, 85°. (Note: not available for single angle gloss meter.)

Statistics		Measure				
S006	S102316	16:35	2015.10.23			
T003	44.5	75.2	89.8	6/6		
	44.6					
	Mean	Max	Min	Std.Dev	Diff	Result
20	44.3	47.7	41.9	2.8	-0.2	Pass
60	74.8	76.1	72.9	1.5	-0.4	Pass
85	90.4	90.8	89.8	0.5	-0.6	Pass
Delete		Menu				

Figure 12: Multi-Angle Measurement in Statistical Mode

“T003 44.5 75.2 89.8” is the standards value of the Statistics Measurement: T003 is the standard’s record number, 44.5 is the value under angle 20°, 75.3 is the value under angle of 60°, 89.8 is the value under the angle of 85°.

3.3.3 Continuous Mode

Single angle measurement: as shown in figure 13.

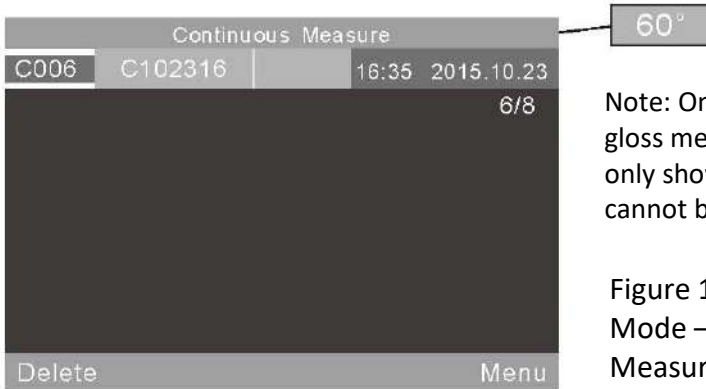

Note: On the single angle gloss meter, this icon will only show one angle and cannot be selected.

Figure 13: Continuous Mode – Single Angle Measurement Mode

Select “Continuous Measure”. The screen will open for the continuous mode parameter settings.

“C006” is the current measurement number which begins with the letter “C”. The  icon is a shortcut key for angle selection. (Note: not available for the single angle gloss meter.)

“C102316” is a default name for the measurement record. It is made up of “C”+“month”+“day”+“hour”. “C” means continuous record. “102316” means it was measured on October 23 at 16 hrs. The record name can be modified by selecting the record name. It accepts a maximum of 8 characters (numbers or letters), as shown in Figure 23.

2) Multi-angle measurement in Continuous Mode. As shown in Figure 14, the angles are: 20°, 60°, 85°. (Note: not available for single angle gloss meter.)

Continuous Measure				
C006	C102316		16:35	2015.10.23
				6/8
	Value	Mean	Max	Min
20	42.1	44.3	47.7	41.9
60	76.0	74.8	76.1	72.9
85	90.6	90.4	90.8	89.8
Delete		Menu		

Figure 14: Continuous Mode – Multi Angle Measurement

3.4 Connecting to PC

On the Main Menu, select “USB Comm” to enter the interface shown in Figure 15. Follow the instructions to connect the instrument to a PC. Use the USB cable to connect the instrument to the PC first. Click “OK”, the instrument will start “Communicating...”. It is then possible to control the instrument through the software. (Precondition: please install the software on the PC correctly. The software and installation instructions are on the CD itself).

Figure 15: Communicating to a PC



3.5 Printing

An optional printer is available for the gloss meter. Simply connect the instrument to the mini printer and it will automatically print the data when measuring.

4. System Function Description

4.1 Data Management

In the Main Menu, select “Data” to view the data management screen as shown in Figure 16. Data management is mainly for checking and operating the records.

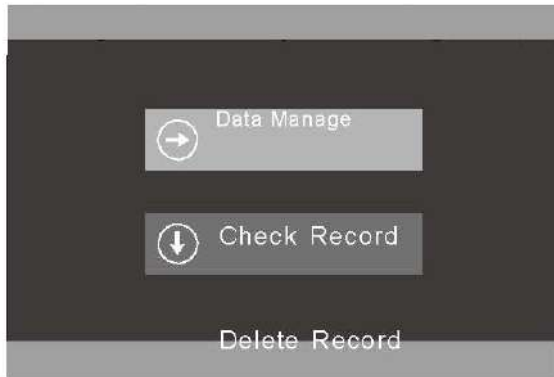



Figure 16: Data Management

4.1.1 Check Record

Select “Check Record”, to view Basic, Statistical and Continuous records as shown in Figure 17.

Figure 17: Check Record



Records can be checked in single angle mode, double angle mode and three angle mode. Select the shortcut  icon to select preferences, as shown in Figure 7. (Note: not available for single angle gloss meter).

1) Check Basic Record

There are 5 records displayed on the screen. When angle 60° is selected, the view will be per Figure 18. When all three angles (20°, 60°, 85°) are selected, the view will be per Figure 19.

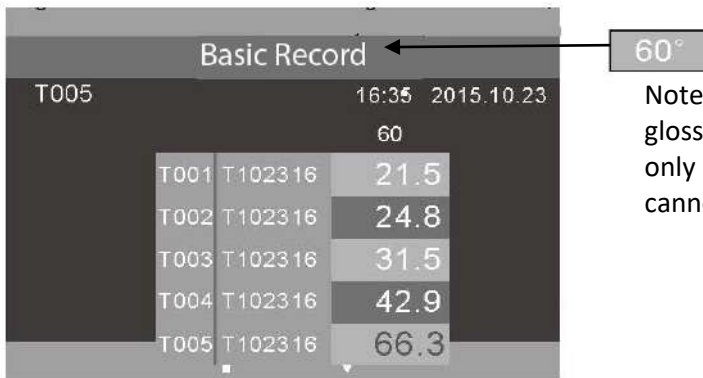

Note: On the single angle gloss meter, this icon will only show one angle and cannot be selected.

Figure 18: Single Angle Record in Basic Mode

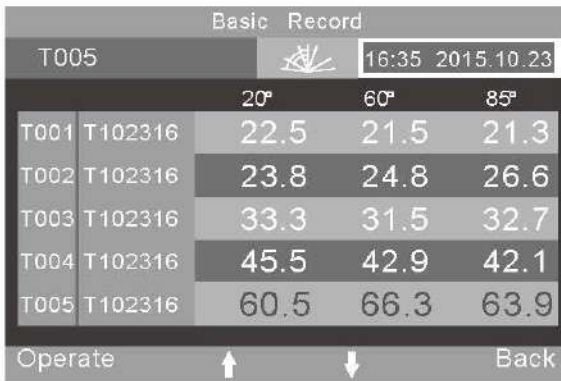

Figure 19: Three Angle Records in Basic Mode

Records can be checked by clicking “↑” and “↓”. When a record is selected, it will be highlighted in yellow as per Figure 20. On release, it will enter the operation interface as shown in Figure 21.

Select “Operate” to edit the last record.

Basic Record				
T005		20 ₀	60 ₀	85 ₀
T001	T102316	22.5	21.5	21.3
T002	T102316	23.8	24.8	26.6
T003	T102316	33.3	31.5	32.7
T004	T102316	45.5	42.9	42.1
T005	T102316	60.5	66.3	63.9

Operate ↑ ↓ Back

Figure 20: Select Basic Record

Edit Name
Standard Entering
Search

OK Back

Figure 21: Basic Record Operations

Delete Record: Select “Delete Record”, a warning box will appear as shown in Figure 22. Click “OK”, to delete the selected record. Click “Back” to prevent deletion.

Edit Record Name: Select “Edit Name” to edit the current record name (maximum 8 characters). On completion, click “OK” to save.

Standard Entering: Select “Standard Entering” to transfer the selected record to a standard record for statistic measurement.

Search: Users can search the record by “Search Index” and “Search Name”.



Figure 22: Deletion Warning Box

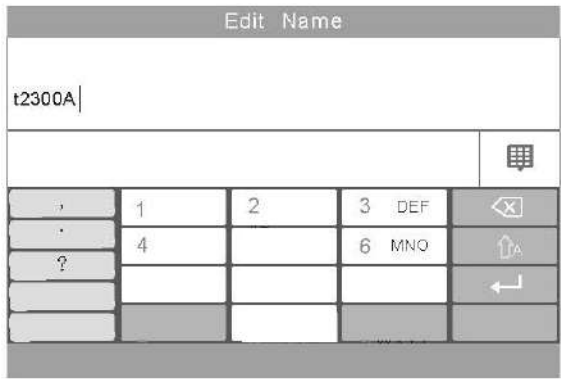

Figure 23: Edit Name

2) Check Statistical Record

When the 60° angle is selected, the view will display just the one record, as shown in Figure 24. When the 20°, 60° and 85° angles are selected, the view will be per Figure 25.

Click the record name “S102316” to modify it per above.



	Mean	Max	Min	Std.Dev	Diff.	Result
60	74.8	76.1	72.9	1.5	-0.4	Pass

Figure 24: Single Angle Measurement in Statistical Mode



	Mean	Max	Min	Std.Dev	Diff.	Result
20	44.3	47.7	41.9	2.8	-0.2	Pass
60	74.8	76.1	72.9	1.5	-0.4	Pass
85	90.4	90.8	89.8	0.5	-0.6	Pass

Figure 25: Three Angle Measurement in Statistical Mode



Figure 26: Operation Menu of Statistical Record

3) Check Continuous Record

This operation is the same as “Check Statistical Record”. Please refer to part “2” of this section.

4.1.2 Delete Record

Click “Delete Record”. As shown in Figure 27, there are three modes: “Delete Basic Record”, “Delete Statistical Record” and “Delete Continuous Record”.



Figure 27: Delete Record



Figure 28: Warning Screen

4.2 Mode Selection

On the main menus, select “Mode” to access different mode parameters per Figure 6.

4.3 Mode Parameter

Select “Parameter” to set the mode parameters, as shown in Figure 29.

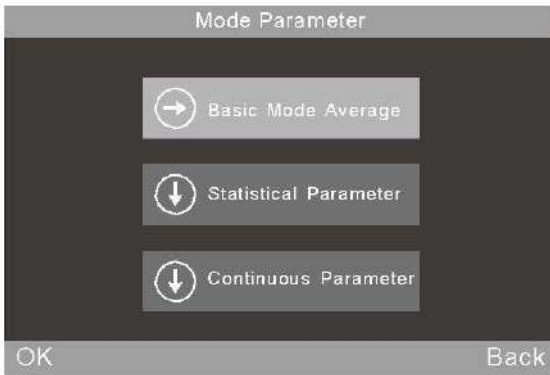

Note: The basic Mode Average function is in the Main Menu on the single angle gloss meter.

Figure 29: Mode Parameter

4.3.1 Average Measurement in Basic Mode

This is an additional functional in Basic Mode. Select “Basic Mode Average” to set the measurement times, as shown in Figure 30. The number range is 0-99.

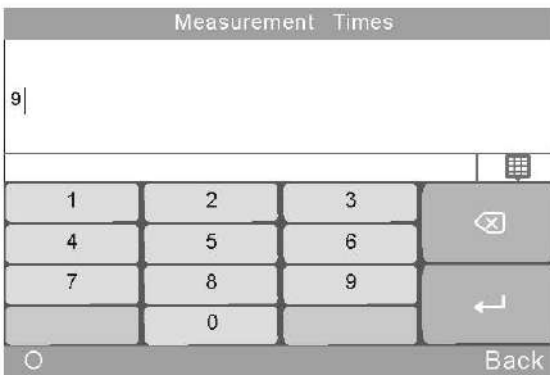

Figure 30:
Measurement
Time

Users can modify the measurement angle, edit the name and delete the record in this mode. All data will be saved in the basic record.

Basic Mode				
T005		16:35 2015.10.23		
6/9		20	60	85
		60.5	66.3	63.9
T001	T102316	22.5	21.5	21.3
T002	T102316	23.8	24.8	26.6
T003	T102316	33.3	31.5	32.7
T004	T102316	45.5	42.9	42.1
T005	T102316	60.1	66.0	63.8
Delete		Menu		

Figure 31: Multi-angle Measurement in Basic Mode Average

4.3.2 Statistical Mode Parameter

Users can set measurement times, difference switch, select standard and input standard.

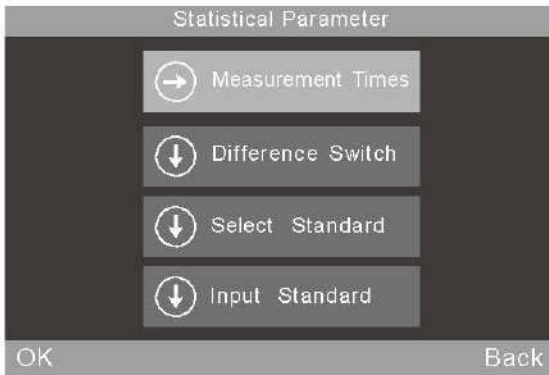

Figure 32: Sub-menu of Statistical Mode Parameter

1) Measurement Times

Measurement times can be set from a range of 1 to 99.

The instrument will automatically calculate and display the average value (mean), maximum value and minimum value. If the 'difference switch' is also activated, it will also display the standard deviation, difference value and results.

2) Difference Switch

When the 'difference switch' is not activated, the statistic measurement only evaluates the average value, maximum value and minimum value. It will not show the comparative function and deviation of the sample against the standard, per Figure 33.

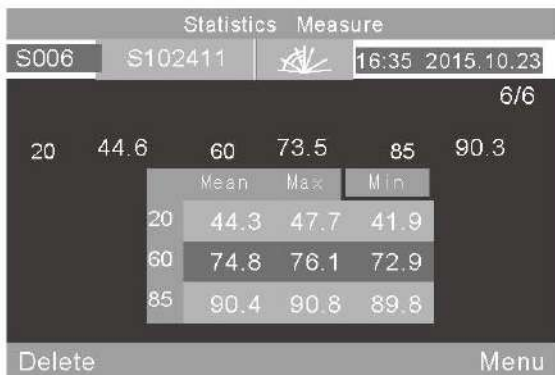

Figure 33: Statistic Measurement When Difference Switch is not activated

When the 'difference switch' is activated, it will display a comparison of the data with to the standard sample, as shown in Figure 11 and 12 (note: the single angle gloss meter only shows a single angle value).

3) Select Standard

The standard of statistics measurement automatically defaults to the last reading of the basic record. If another record should be used as the standard, click “Select Standard” and use the arrows to scroll to the selection.

Alternatively, the “Search” index may be used to search for the name of the record to be used as the standard.

Basic Record				
T005		20°	60°	85°
T001	T102316	22.5	21.5	21.3
T002	T102316	23.8	24.8	26.6
T003	T102316	33.3	31.5	32.7
T004	T102316	45.5	42.9	42.1
T005	T102316	60.5	66.3	63.9

Search ↑ ↓ Back

Figure 34: Entering Multi-Angle Standard

4) Input Standard

It is possible to input data from a new basic record data as the standard of statistical mode. This new record will automatically be saved in the basic record database.

Select “Input Standard” as shown in Figure 35. If single angle mode is selected in the interface “Check Basic Record”, it is only possible to input the corresponding single angle standard. If multi-angle mode has been selected, it is possible to input the multi- angle standards sequentially. Select “OK” to the edit name as shown in figure 23.

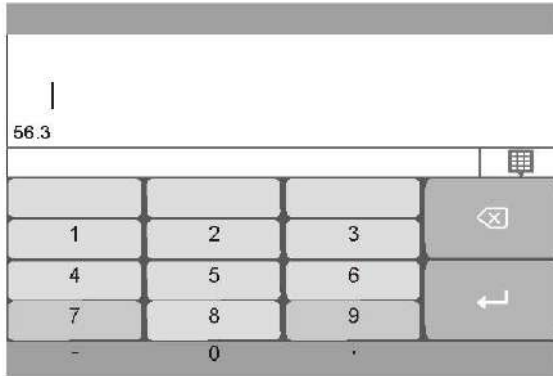

Figure 35: Input Standard

4.3.3 Continuous Mode Parameter

There are two functions: Measurement Times and Interval Time, as shown in Figures 36 and 37.

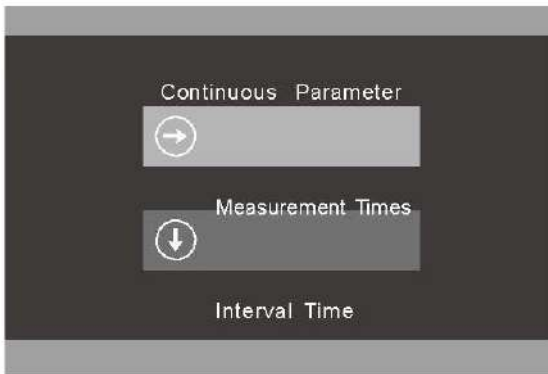

Figure 36: Sub Menu of Continuous Mode Parameter

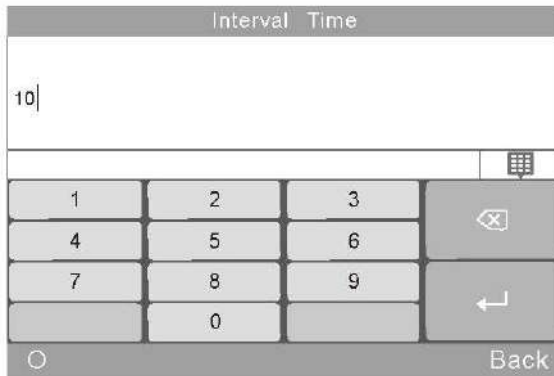

Figure 37: Interval Time Setting in Continuous Mode

4.4 Angle Selection

Select 'Angle' to choose the measurement angles according to requirements as shown in Figure 7.

4.5 Tolerance Settings

Select 'Tolerance' as shown in Figure 38 to define the tolerance between the standard against which the statistical data can be compared. If the deviation to the standard is within the tolerance range, the sample will be qualified.



Figure 38: Tolerance Setting

4.6 Function Setting

Select 'Setting' to set other functions as shown in Figure 39. These include:

Auto Save:	On or Off
Time Setting:	Time and Date
Language Setting:	Select Accordingly
Backlight Time ¹ :	As required
Operation Mode:	Right or Left Handed Operation
Screen Brightness:	As required
Buzzer Switch:	On/Off for sound when measuring
Restore Factory Settings ² :	

¹) Note: the instrument will turn off one minute after the backlight goes out.

²) Note: When Restore Factory Settings is selected, a warning menu will appear. Please proceed with caution. If OK is selected, the instrument will restore factory settings and **all records will be cleared.**

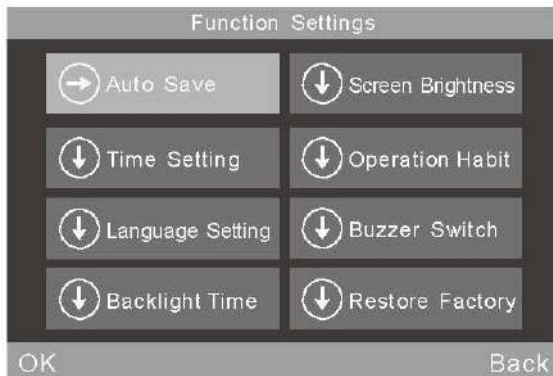

Figure 39: Function Settings

5. Routine Maintenance

1) The gloss meter is a precision instrument. Please operate and store it in a laboratory environment (temperature approx. 20°C, standard atmospheric pressure, humidity of 50 ~ 70RH). Avoid using it in a humid environment, in areas of strong electromagnetic fields, intensive lighting, or dusty areas.

2) The calibration plate is a precise optical component. Avoid any damage from sharp objects, avoid dirt and avoid exposing it to sunlight. Clean the plate regularly with a soft cloth and alcohol by rubbing in one direction. Ensure there are no tiny particles or sundries on the cloth. Clean the plate before calibration to ensure accuracy of measurements.

Note: Do not use acetone solvent.

3) In order to ensure the accuracy of the instrument, it is recommended that it should be returned to the factory or a qualified Local National Institute of Metrology for calibration once a year.

4) Please see Section 3.2.2 for details on how to modify the calibration value.

5) The gloss meter is powered by a built-in battery. If the instrument is not being used for a long time, it is recommended to charge it every two ct the battery and extend its lifetime.

6) Do not attempt to clean the inside of the instrument. This should only be done by the manufacturer.

5. Technical Specifications

Measurement Angle	20°/ 60°/ 85°/ 20°60°85°		
Standard	ISO 2813, GB/T 9754, ASTM D 523, ASTM D 2457		
Measuring Area (mm)	20°: 10x10, 60°: 9x15 (small aperture: 1.5x2), 85°: 5x36		
Measuring Range	20°:0-2000GU 60°:0-1000GU 85°:0-160GU		
Division Value	0.1GU		
Range	0-10GU	10-100GU	100-2000GU
Repeatability	±0.1GU	±0.2GU	±0.2%GU
Reproducibility	±0.2GU	±0.5GU	±0.5%GU
Chromaticity Corresponding	Corresponding with CIE 1931(2°) under CIE C light source		
Measuring Time	0.5second		
Dimension	L*W*H : 160mm*75mm*90mm		
Weight	350g		
Battery	3200mAh Li-ion Battery, >10000 times (within 8 hours)		
Display	TFT 3.5inch, touch screen, resolution: 320*480		
Interface	USB/RS-232		
Storage	Basic mode: 1000, Statistical Mode:5000, Continuous		
Software	GQC6 Quality Control Software with QC report printing function and more extended functions.		
Operation Temperature	0 ~ 40 °C (32 ~ 104 ° F)		
Storage Temperature	- 20 ~ 50 °C (- 4 ~ 122 ° F)		
Humidity	<85% relative humidity, no condensation		
Standard Accessories	Power Adapter, USB cable, User Manual, CD (Including QC software), Wiping Cloth, Calibration Plate		
Optional Accessories	Miniature Printer		

*Note: The specifications are subject to change without notice.

6. Sales Offices

Germany

Tintometer GmbH
Schleefstraße 8-12
44287 Dortmund
Germany
Tel: +49 (0)231/94510-0
Fax: +49 (0)231/94510-20
Email: sales@tintometer.de

North America

Tintometer Inc
6456 Parkland Drive
Sarasota
Florida 34243
USA
Tel: +1 941 756 6410
Fax: +1 941 727 9654
Email: sales@tintometer.us

Switzerland

Tintometer AG
Hauptstraße 2
5212 Hausen AG
Switzerland
Tel: +41 (0)56/4422829
Fax: +41 (0)56/4424121
Email: info@tintometer.ch

India

Tintometer India Pvt. Ltd.

B-91, A.P.I.E. Sanath Nagar,
Hyderabad
500018
India
Tel: +91 (0) 40 4647 9911
Toll Free: 1 800 102 3891
Email: indiaoffice@tintometer.com

United Kingdom

The Tintometer Ltd
Lovibond House, Sun Rise Way
Solstice Park
Amesbury SP4 7GR
Tel: +44(0)1980 664800
Fax: +44(0) 1980 625412
Email: sales@tintometer.com

South East Asia

Tintometer South East Asia
Unit B-3-12-BBT One Boulevard,
Lebuh Baku Nilam 2,
Bandar Bukit Tinggi, Klang, 41200, Selangor D.E
MALAYSIA.
Tel: +60 (0) 3 3325 2285/6
Fax: +60 (0) 3 3325 2287
Email: lovibond.asia@tintometer.com

China

Tintometer China
Room 1001, China Life Tower,
16 Chaoyangmenwai Avenue
Beijing 100020
China
Tel: +89 10 85251111 ext.330
Fax: +86 10 85251001
Email: chinaoffice@tintometer.com

Lovibond® and Tintometer® are registered trademarks of the Tintometer® Group. All translations and transliterations of Lovibond® and Tintometer® are asserted as trademarks of the Tintometer® Group.

www.lovibond.com

